

ROSTA Anti-vibration Mounts

Shock and Vibration absorbing Machine Mounts

high degree of isolation – tearproof – absorption of solid-borne noise



ROSTA Anti- highly elastical and fully tearproof vibration

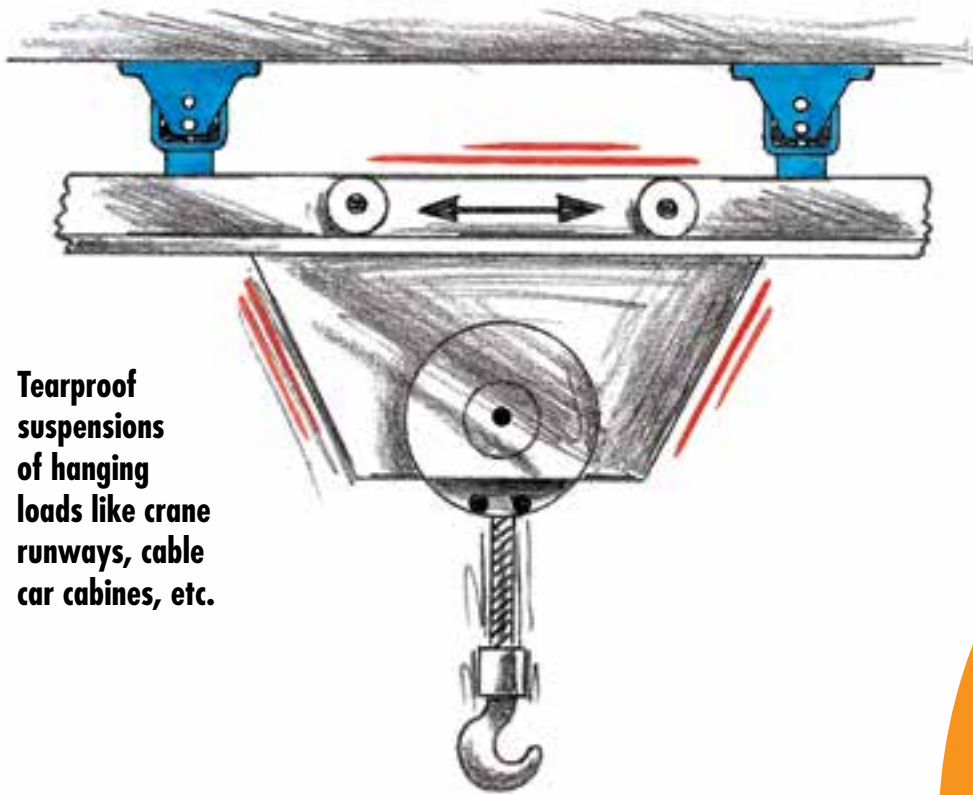

Tearproof suspensions of hanging loads like crane runways, cable car cabins, etc.

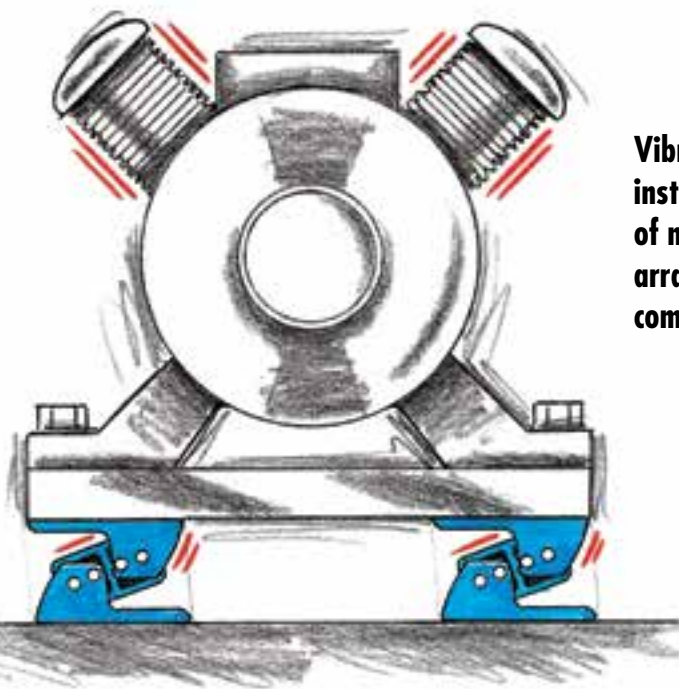

Vibration-free installations of motor test arrangements, compressors, etc.

ESL



N



**long lasting
maintenance-free
absorbing solid-borne noise**

vibration Mounts

dampers based on torsional rubber pivots

Wide range of standardized mounts, for load capacities of 20–2'000 kg

Shock absorbing levelling feet for machine mounting

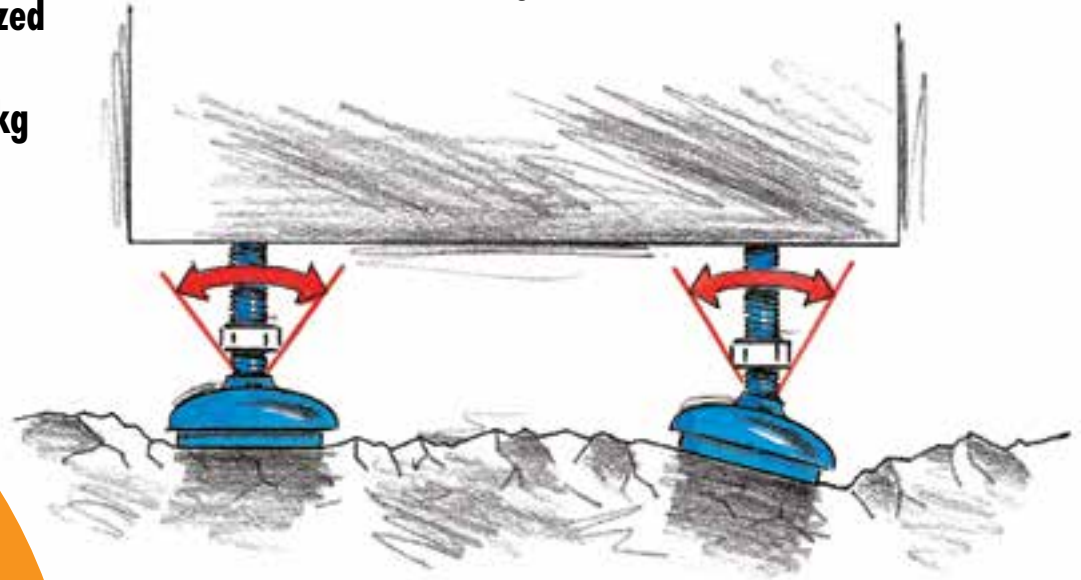

V



ISOCOL



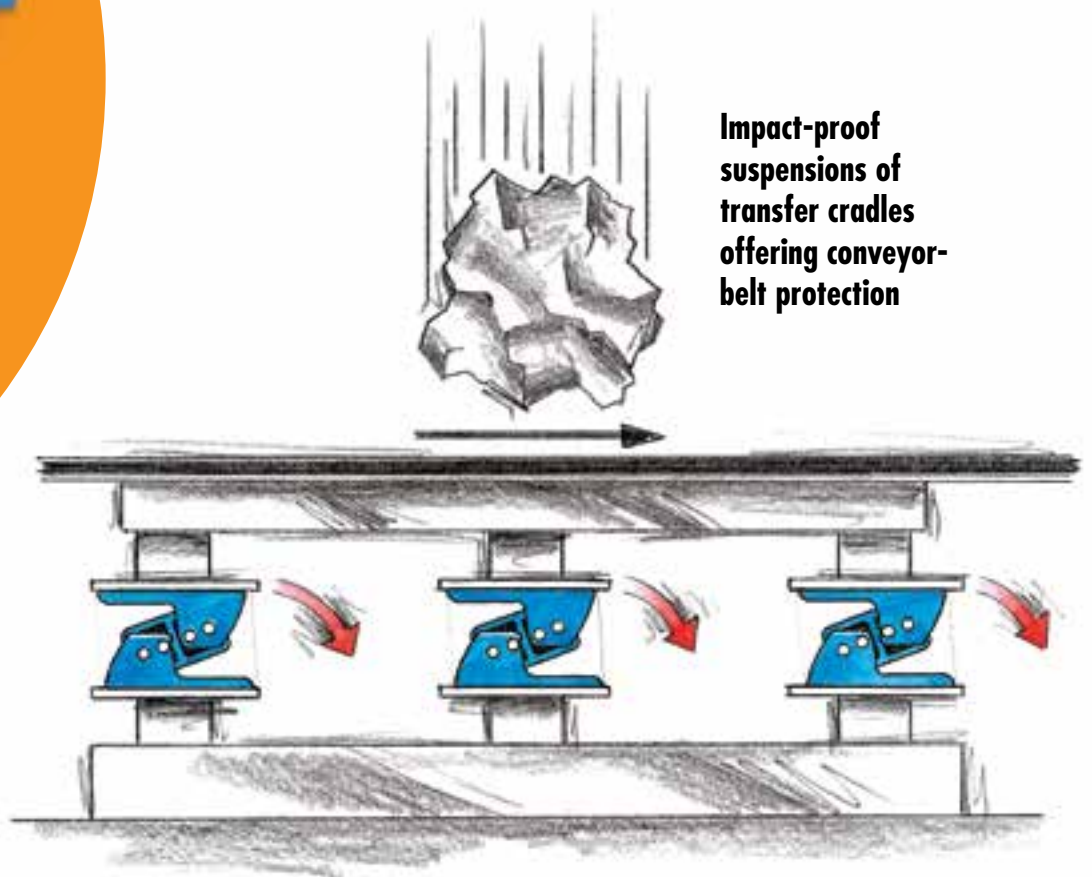

Impact-proof suspensions of transfer cradles offering conveyor-belt protection



Anti-vibration Mounts

Selection table for Anti-vibration Mounts

Type	Description	Details	Illustration
ESL	<p>Anti-vibration Mounts for the absorption of tensile, pressure and shear load. Also ideal for wall and ceiling installations.</p> <p>8 load sizes from 200 N to 19'000 N per mount.</p> <p>Natural frequency between 3,5 – 8 Hz. Mounts are mainly used for overcritical machine installations (machine frequency > mount frequency).</p>	Page 3.8 – 3.9	
V	<p>Anti-vibration Mounts for the absorption of tensile, pressure and shear load. Also ideal for wall and ceiling installations.</p> <p>6 load sizes from 300 N to 12'000 N per mount.</p> <p>Natural frequency between 10 – 30 Hz. Mounts can be used for subcritical machine installations (machine frequency < mount frequency).</p>	Page 3.10 – 3.11	
N	<p>Mounting Feets consisting of insulating plate, glued-on top cover with built-in levelling jackscrew with spherical joint for compensation of up to 5° of floor unevenness. Insulating plate oil- and acid-proof.</p> <p>3 load sizes from 1'500 N to 20'000 N per mount.</p> <p>Natural frequency between 19 – 25 Hz.</p>	Page 3.12	
NOX	<p>Mounting Feets consisting of insulating plate, stainless steel glued-on top cover with built-in stainless levelling jackscrew with spherical joint for compensation of up to 5° of floor unevenness. Insulating plate oil- and acid-proof.</p> <p>2 load sizes from 5'000 N to 20'000 N per mount.</p> <p>Natural frequency between 19 – 22 Hz.</p>	Page 3.12	
Base plate P	<p>Accessories: For all N and NOX mounting feet light metal cast base plates are available for the compensation of possible shear loads and/or for the positioning of the installation on the floor.</p>	Page 3.12	
ISCOL	<p>Adhesive cushioning plates, self-adhesive plates for the installation of smaller machines/equipments. Plates oil- and acid-proof. (Adhesive power can be increased by moistening the plate with nitro thinner.)</p>	Page 3.13	
ISCOL U	<p>Adhesive cushioning plates, self-adhesive plates with glued-on cast cover. With central hollow in cover for the positioning of the levelling jackscrew – also with lateral stop bar for machine positioning.</p>	Page 3.13	

Further information to customized elements and installation examples as from page 3.14.

Technology Anti-vibration Mounts

Manufacturers and suppliers of anti-vibration mounts usually offer different types of machine mount with varying natural frequencies to meet the required **detuning** between the excitation frequency of the machine and the natural frequency of the anti-vibration mount.

1. Isolation of Oscillations and Shocks

The vibration technology basically differentiates between two principal types of oscillation appearances (fig. 1). Sinusoidal oscillations of working equipments are usually amortised in an **overcritical** installation manner, shocks and impacts in a **subcritical** mounting manner.

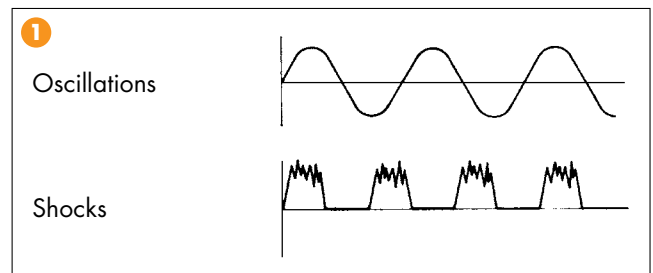

Frequency Proportion λ (fig. 2)

- $\lambda > \sqrt{2}$: **Overcritical**
efficient vibration isolation, clearly definable effectiveness, also efficient solid-borne noise absorption
- $\lambda = 1$: **Resonance field**
uncontrolled swing-up, in the long term destructive for machine and mounts
- $\lambda < 1$: **Subcritical**
vibration isolation not definable, isolation results have to be measured out (before and after mount installation).

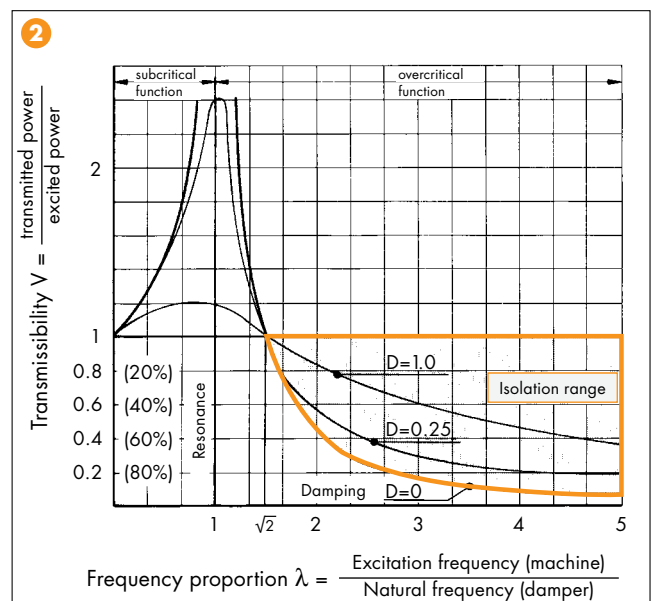

Overcritical installations ($\lambda > \sqrt{2}$)

On overcritical installations the natural frequency of the mounts should show at least a detuning factor of 1:1,414 in regard to the excitation frequency of the machine. Usually, very efficient anti-vibration mounts feature a deep deflection capability offering a low natural frequency. Most of the generators, compressors, blowers and chargers are, therefore, in **overcritical** manner installed on relatively "soft" mounts. The resulting **detuning proportion** provides information about the expected **isolation-effectiveness** in % of the machine suspension. The adjacent chart (fig. 3) and the calculation formula (fig. 4) inform about the resulting vibration isolation in %.

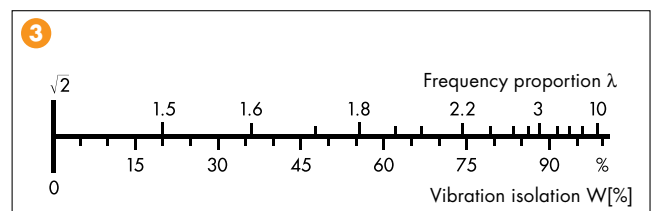

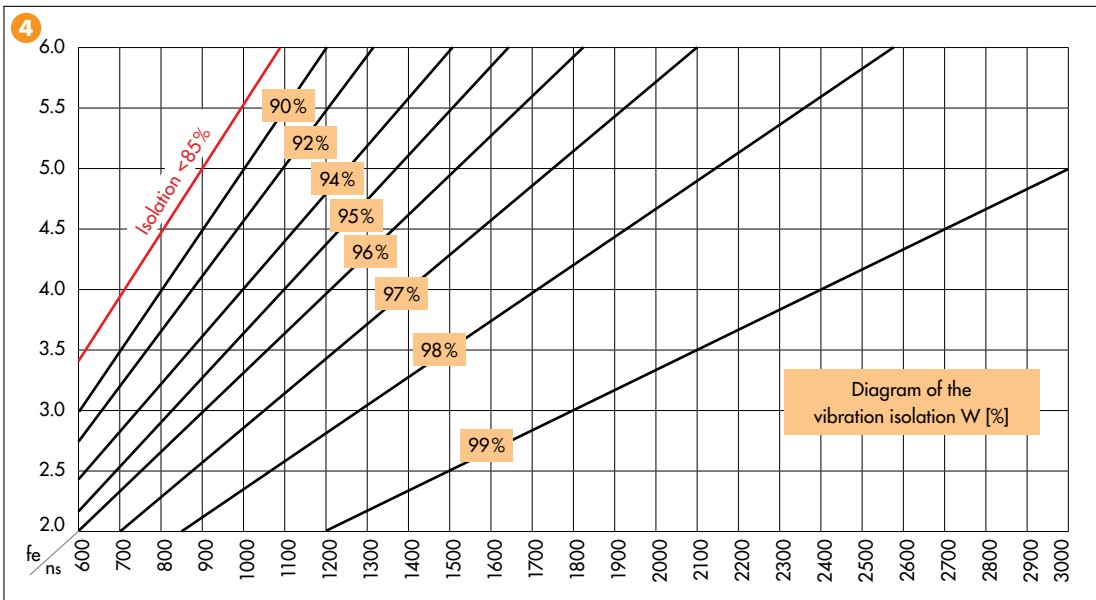

Vibration isolation

$$W = 100 - \frac{100}{\left(\frac{n_s}{60 \cdot f_e}\right)^2 - 1} [\%]$$

n_s =
Revolution exciter
(machine) [rpm]

f_e =
Natural frequency
damper [Hz]

Resonance field ($\lambda = 1$)

At equal values of the excitation frequency and the mount natural frequency an uncontrollable swing-up of machine and damper occurs. In the long run, this appearance will be destructive for machine and mount (fig. 2).

Subcritical installations ($\lambda < 1$)

On subcritical installations (fig. 2) an anti-vibration mount with high mechanical stiffness and only small deflection behaviours should be chosen, e. g. ROSTA V mounts (high machine stability on mounts). In spite of the fact that the degree of isolation is not definable, this suspension efficiently absorbs **shocks** and **impacts** generated by relatively slow turning machines like e. g. mixers, crushers (cone-crushers), punching presses, sheet iron shears, etc. On **subcritical** installations the degree of isolation is not definable. Isolation results have to be measured out (before and after mount installation).

2. Solid-borne Noise Isolation

Whereas the isolation of mechanically generated oscillations and shocks are determined and dissipated by means of the aforementioned vibration dampening theory, the **solid-borne noise isolation** is subject to the technology of wave mechanics. The dampening effect is related to the proportion of the relevant acoustic resistance (acoustic resistance or wave resistance = acoustic velocity x material density). The adjacent chart (fig. 5) shows some comparative values of the resulting isolation proportions. Generally, using a rubber-steel composite mount, an ideal isolation result of the solid-borne noise can be expected – through the entire frequency range.

Acoustic isolation, related to steel:	Steel	1 : 1
	Bronze	1 : 1.3
	Cork	1 : 400
	Rubber	1 : 800
	Air	1 : 90 000

3. Active and Passive Isolation

Active or direct isolation (fig. 6) means the direct absorption of oscillations, vibrations and shocks of a running machine by anti-vibration mounts, i. e. to prevent **directly** the transfer of the numerous machine vibrations into the sub-structure, basis frame and entire building. For the anti-vibration mount selection the knowledge of the interfering frequency (**disturbance frequency**), the stiffness of the machine structure and its gravity center as well as of the specific machine location in the building is required. Active isolations are usually **overcritical** machine installations on anti-vibration mounts (e. g. on ROSTA ESL mounts).

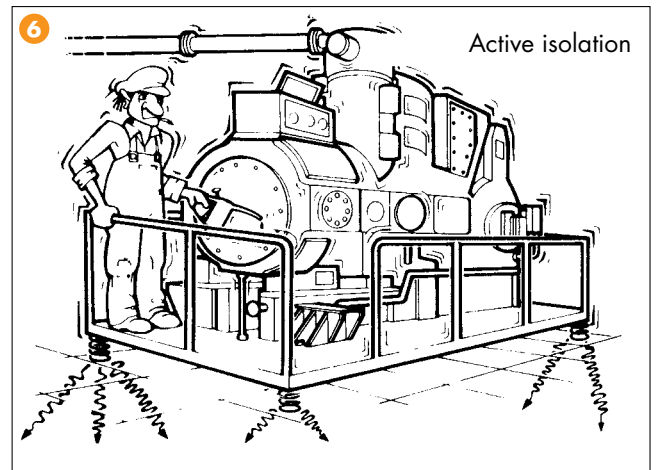

Passive or protective isolation (fig. 7) means to install a protective barrier between all kind of existing vibrations and shocks occurring in a factory or workshop towards sensitive installations like e. g. weighing and measuring instruments, laboratory equipment or electronic control units. The vibration technological situations usually vary in each case and are related to environmental situations, too. Often shocks and impacts come from outside, e. g. from motorways, railways, building sites or tooling machines, like punching presses, etc. Generally, the sensitive equipments shall be protected by installing them on rather "soft" anti-vibration mounts, e. g. ROSTA ESL or AB-D mounts absorbing most of these environmental impacts. It is frequently recommendable to consult also an engineering company having the tools and instruments to analyse the specific vibration appearances.

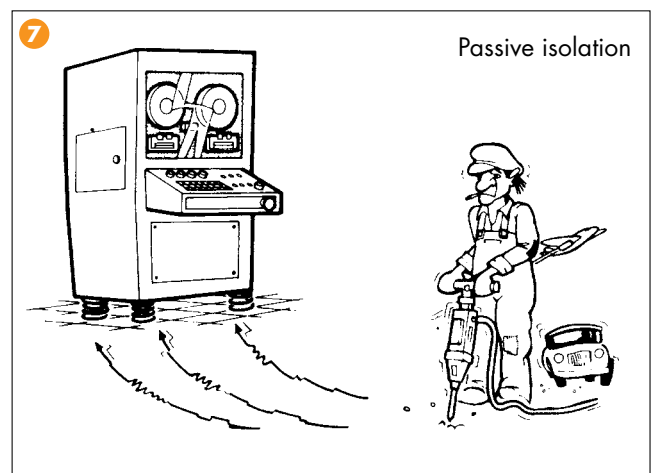

Protective suspension mounts for e.g. tooling machines are usually rather "hard" and show only little deflection under load. Too soft tooling machine mounts could activate bending of the machine base what would influence negatively the precision of the work piece machining. Therefore, mounting feet for tooling machines are often consisting of hard rubber cushions deflecting only a few millimetres under load, but "shield" all combined vibration and shock appearances from the sensitive precision machine. Transmitted shocks and vibrations could affect the clean surface finishing of the work piece. Of course, in the interest of the fully horizontal positioning of the tooling machines, these anti-vibration mounts have to dispose of a levelling jackscrew with spherical joint for the compensation of the possible floor unevenness (e. g. ROSTA N or NOX mounts).





Anti-vibration Mounts

Type ESL

up to ESL 45

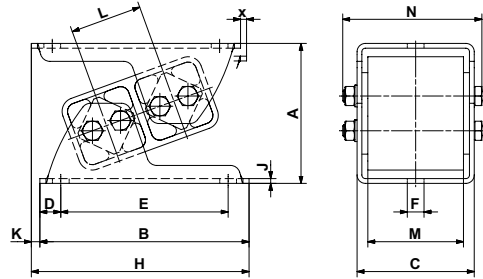

as from ESL 50

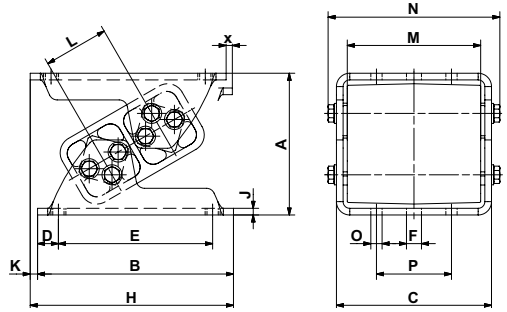

Art. No.	Type	Load Gmin. – Gmax. [N] on Z-axis	A un- loaded	A* max. load	B	C	D	E	øF	H	J	K	L	M	N	Weight [kg]
05 021 001	ESL 15	200 – 550	54	43	85	49	10	65	7	91	2	5.5	25.5	40	58.5	0.4
05 021 002	ESL 18	450 – 1'250	65	51	105	60	12.5	80	9.5	111	2.5	5.5	31	50	69	0.6
05 021 003	ESL 27	700 – 2'000	88	68	140	71	15	110	11.5	148	3	8	44	60	85.3	1.3
05 021 004	ESL 38	1'300 – 3'800	117	91	175	98	17.5	140	14	182	4	7	60	80	117	3.4
05 021 005	ESL 45	2'200 – 6'000	143	110	220	120	25	170	18	235	5	15	73	100	138	5.3
05 021 016	ESL 50	4'000 – 11'000	170	138	235	142	25	185	18	244	6	9	78	120	162	10.8
05 021 017	ESL 50-1.6	5'500 – 15'000	170	138	235	186	25	185	18	244	8	9	78	160	206	15.4
05 021 018	ESL 50-2	7'000 – 19'000	170	138	235	226	25	185	18	244	8	9	78	200	246	17.8

Art. No.	Type	Natural frequency Gmin. – Gmax. [Hz]	O	P	x max.	Material structure (zinc-plated screws)
05 021 001	ESL 15	8.2 – 5.8	-	-	1.5	Light metal profiles, steel brackets, ROSTA blue painted
05 021 002	ESL 18	7.5 – 5.0	-	-	1.9	
05 021 003	ESL 27	6.2 – 4.5	-	-	2.7	
05 021 004	ESL 38	5.5 – 4.0	-	-	3.6	
05 021 005	ESL 45	5.0 – 3.5	-	-	4.4	
05 021 016	ESL 50	5.0 – 3.5	13.5	90	10	Light metal profiles, cast housings, steel brackets, ROSTA blue painted
05 021 017	ESL 50-1.6	5.0 – 3.5	13.5	90	10	
05 021 018	ESL 50-2	5.0 – 3.5	13.5	90	10	

The max. load on **X-axis** should not exceed **200%** of the Z-axis capacity.

The max. load on **Y-axis** should not exceed **20%** of the Z-axis capacity.

Applicable on tensile, pressure and shear load.

These types can be combined with one another (identical heights and operation behaviour)

* compression load Gmax. and final cold flow compensation (after approx. 1 year).

Guidelines concerning customized mounts and examples as from page 3.14.



Anti-vibration Mounts

Type ESL

Deflection curves and cold flow behaviour

The below mentioned deflection values are comprising the initial cold flow, occurring after a few hours of operation. The final cold flow (after one year) is usually $s \times 1.09$. The mentioned deflection values are not suitable for type testing. Please consult also our tolerance data in the general catalogue, chapter "Technology".

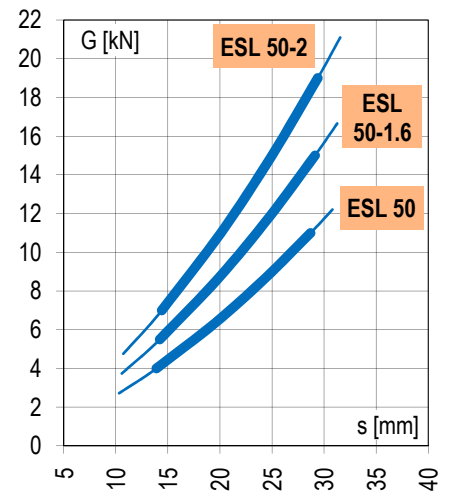
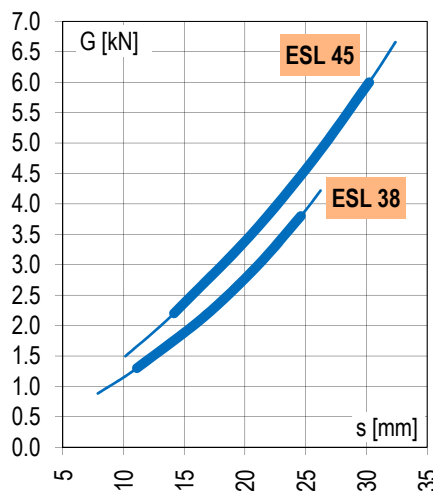
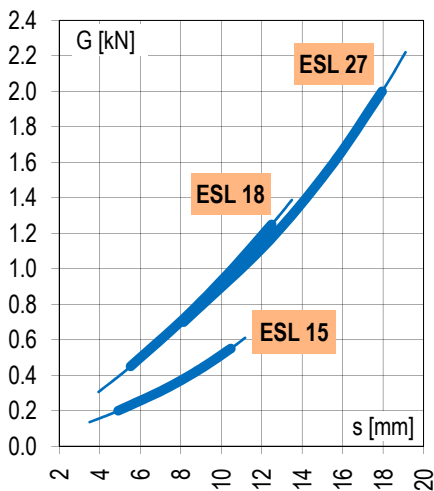
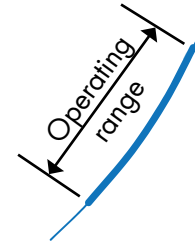

Installation guidelines

The ESL elements must generally be installed in the same direction.

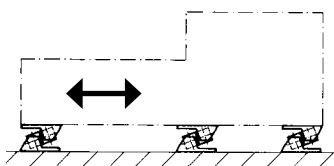

Dynamic forces longitudinal

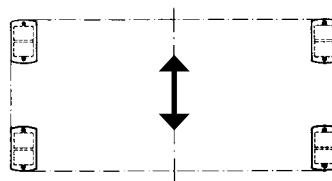

Dynamic forces lateral

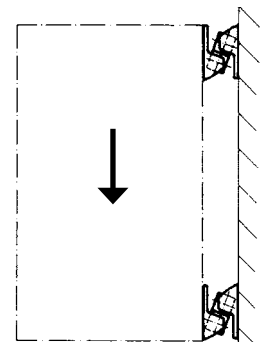

Wall mounting
(Mounting direction should be complied)

Applications

For active and passive isolation of vibrations and maximum damping of solid-borne noise transmission in weighbridges and scales, measuring systems, control equipment, rotary machinery such as compressors, refrigerating systems, blowers, pumps, mills, mixers, shock-absorbent buffers, etc.



Anti-vibration Mounts

Type V

up to V 45

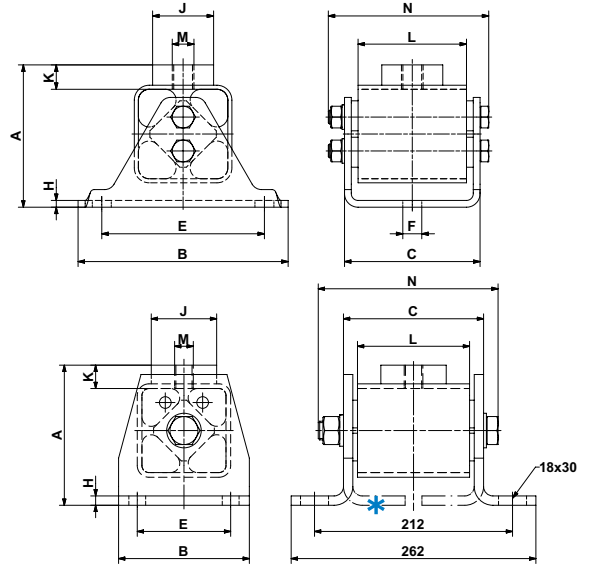

V 50

* Alternativ mounting position 180° turned.

Art. No.	Type	Load Gmin. – Gmax. [N] on X- and Z-axis	A	B	C	E	øF	H	øJ	K	L	M	N	Weight [kg]
05 011 001	V 15	300 – 800	49	80	51	55	9.5	3	20	10	40	M10	59	0.3
05 011 002	V 18	600 – 1'600	66	100	62	75	9.5	3.5	30	13	50	M10	74	0.7
05 011 003	V 27	1'300 – 3'000	84	130	73	100	11.5	4	40	14.5	60	M12	85	1.3
05 011 024	V 38	2'600 – 5'000	105	155	100	120	14	5	45	17.5	80	M16	117	2.7
05 011 005	V 45	4'500 – 8'000	127	190	122	140	18	6	60	22.5	100	M20	143	4.6
05 011 006	V 50	6'000 – 12'000	150	140	150	100	-	10	70	25	120	M20	193	7.5

Art. No.	Type	Natural frequency Gmin. – Gmax. [Hz]	Material structure (zinc-plated screws)
05 011 001	V 15	30 – 23	Light metal profiles, welded steel housings, ROSTA blue painted
05 011 002	V 18	25 – 15	
05 011 003	V 27	28 – 20	
05 011 024	V 38	14 – 12	
05 011 005	V 45	15 – 12	
05 011 006	V 50	12 – 10	

The max. load on **Y-axis** should not exceed **20%** of the X- resp. Z-axis capacity.

Momentary shock loads of 2.5 g in X- and Z-axis admissible.

Applicable on tensile, pressure and shear load.

Further information to customized elements and installation examples as from page 3.14.

Anti-vibration Mounts

Type V

Deflection curves

The mentioned deflection values are not suitable for type testing. Please consult also our tolerance data in the general catalogue, chapter "Technology".

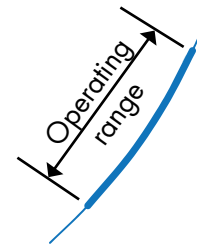
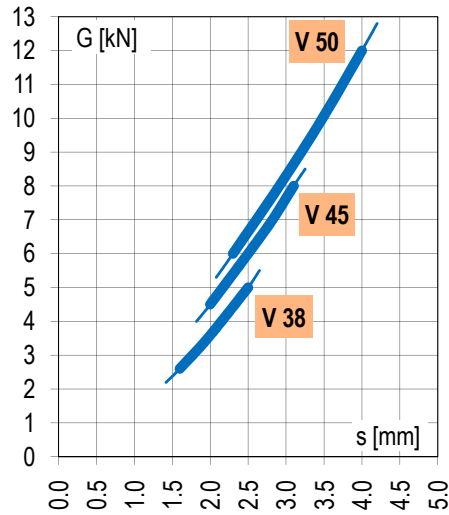
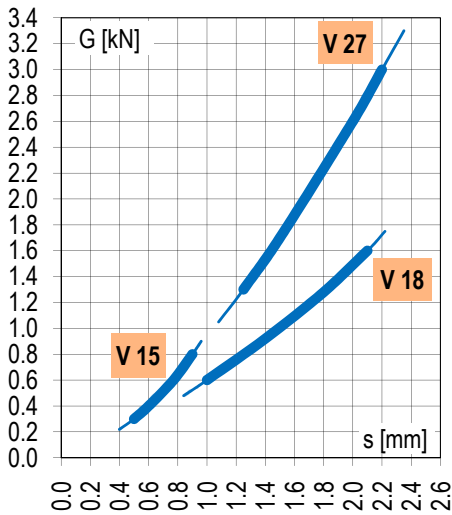

Installation guidelines

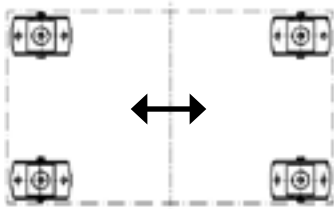

Dynamic forces longitudinal

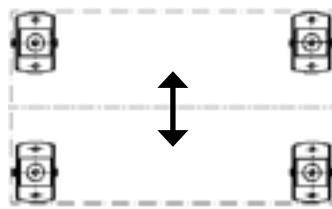

Dynamic forces lateral

45° diagonal configuration by rotary motions. Reduced load capacities.

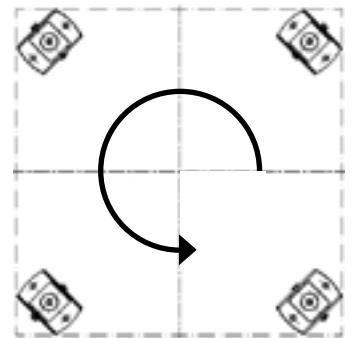

e. g. mixer, crusher installation

Applications

For active and passive isolation of vibrations and damping of solid-borne noise transmission in crushing plants, compressors, blowers, pumps, rotary converters, generators, mills, crane track supports, etc.

Mounting Feet

Type N
Type NOX

Accessory:
Base plate P

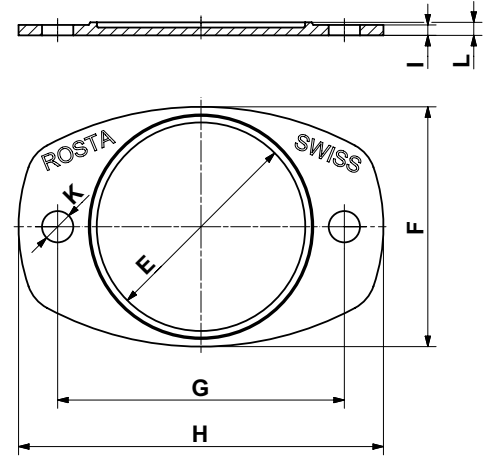
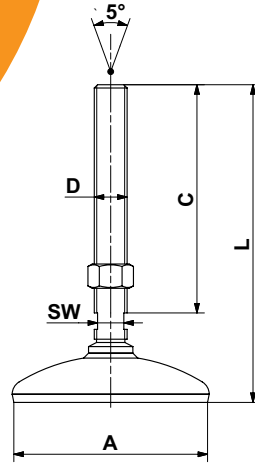

N and NOX

Art. No.	Type	Load Gmin. – Gmax. [N]	Natural frequency Gmin. – Gmax. [Hz]	øA	C	D	L	SW	Weight [kg]	Material structure (rubber pad NBR with 50 ShA)
05 058 001	N 80 M12	1'500 – 6'000	25 – 22	80	55	M12	100	10	0.3	zincd, cover blue painted
05 058 002	N 80 M16	5'000 – 12'000	22 – 19	80	136	M16	182	13	0.5	zincd, cover blue painted
05 058 102	NOX 80 M16									stainless steel 1.4301 and 1.4305
05 058 004	N 120 M20	10'000 – 20'000	22 – 19	120	139	M20	195	16	1.0	zincd, cover blue painted
05 058 103	NOX 120 M20									stainless steel 1.4301 and 1.4305

Base plate P

Art. No.	Type	Accessory to	øE	F	G	H	I	øK	L	Weight [kg]	Material structure
05 060 101	P 80	N / NOX 80	80	92	110	140	4	12	5	0.1	Light metal cast
05 060 102	P 120	N / NOX 120	120	135	170	210	5	16	7	0.3	

Options by high volume supplies

- other thread sizes and lengths
- higher load capacities
- other painting
- imprint of company logo

Applications

For the isolation of vibrations and solid-borne noise, also for machinery and apparatus requiring levelling, such as air conditioning plants, woodworking machinery, pumps, tanks, containers, transport systems, tooling machines, assembly lines and workshop equipment.

For further information to customized elements and installation examples as from page 3.14.



Adhesive cushioning plates

Type ISOCOL

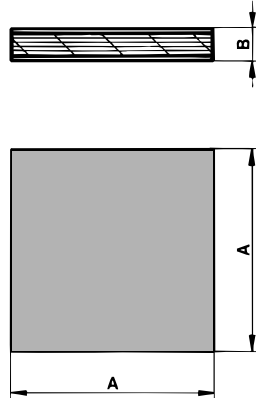

Type ISOCOL U

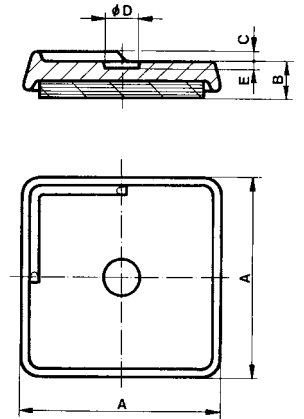

Art. No.	Type	Load Gmin. – Gmax. [N]	Natural frequency Gmin. – Gmax. [Hz]						Weight [kg]	Material structure
				A	B	C	øD	E		
05 030 001	ISOCOL 50	500 – 1'500	25 – 16	50	8	-	-	-	0.02	Rubber NBR/SBR with 40 ShA. ISOCOL U with cast cover.
05 040 001	ISOCOL U 50			60	14	3	11	2	0.15	
05 030 002	ISOCOL 80	1'200 – 3'800	25 – 16	80	8	-	-	-	0.05	
05 040 002	ISOCOL U 80			90	15	3	14	2	0.40	
05 030 003	ISOCOL 400	32'000 – 96'000*	25 – 16	400	8	-	-	-	1.30	

Installation Guidelines

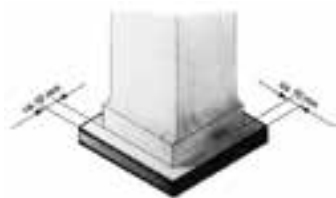

In order to obtain optimal stabilisation of the machine, it is recommended to allow the ISOCOL plates to protrude approx. 10 mm from the machine base. The single plates must be mounted such as the load is evenly distributed.



In cases where levelling is not necessary the ISOCOL U elements can be layed directly under the machine base, up to the lateral stops. Additional fixation is not necessary.



In case the machine frame includes a levelling screw, the central hollow of the ISOCOL U mounting is placed directly under the screw, which allows the accurate levelling.

Applications

For extremely low installation situations, for the damping of vibrations and solid-borne noise, under air conditioning plants, heating boilers, pumps, office machines, laboratory equipment, wood working machines and workshop equipment, etc.

Notice

The deflection of the cushioning plates by the mentioned max. catalogue load capacities is 1.5 mm.

* Besides the mentioned catalogue dimensions, these cushioning plates are also available in sheet-dimensions 400x400 mm = ISOCOL 400. Relevant footprint shapes can easily be cutted out by means of carpet cutters. Calculation of load capacity with 20 to 60 N/cm².

For further information to customized elements and installation examples as from page 3.14.

ROSTA Anti-vibration Mounts type ESL as impact absorbing suspensions of transfer stations in belt conveyor systems

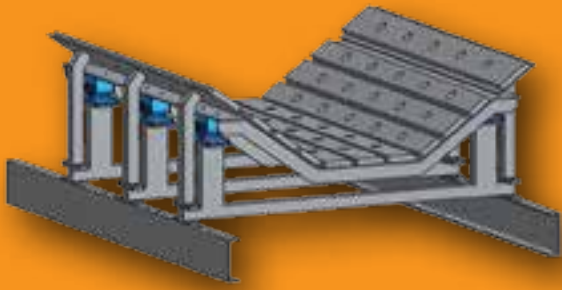

Table: Size and quantity of ESL for the absorption of the occurring kinetic energy

Weight biggest lump [kg]	Height of fall [m]																		
	1.0	1.5	2.0	2.5	3.0	3.5	4.0	4.5	5.0	5.5	6.0	6.5	7.0	7.5	8.0	8.5	9.0	9.5	10.0
5	4	4	4	4	4	4	4	4	4	4	4	4	4	4	4	4	4	4	4
10	4	4	4	4	4	4	4	4	4	4	4	4	4	4	4	4	4	4	4
20	4	4	4	4	4	4	4	4	4	6	6	6	6	6	6	6	6	6	6
30	4	4	4	4	4	6	6	6	6	6	6	6	6	6	8	8	8	8	8
40	4	4	4	4	6	6	6	6	6	8	8	8	8	8	8	8	8	8	8
50	4	4	4	6	6	6	6	6	8	8	8	8	8	8	8	8	8	8	8
60	4	4	6	6	6	6	8	8	8	8	8	8	8	8	8	8	8	8	8
70	4	6	6	6	6	8	8	8	8	8	8	8	8	8	8	8	8	8	8
80	4	6	6	6	8	8	8	8	8	8	8	8	8	8	8	8	8	8	8
90	4	6	6	6	8	8	8	8	8	8	8	8	8	8	8	8	8	8	8
100	4	6	6	8	8	8	8	8	8	8	8	8	8	8	8	8	8	8	8
110	6	6	6	8	8	8	8	8	8	8	8	8	8	8	8	8	8	10	10
120	6	6	8	8	8	8	8	8	8	8	8	8	8	8	10	10	10	10	10
130	6	6	8	8	8	8	8	8	8	8	8	8	8	10	10	10	10	10	12
140	6	6	8	8	8	8	8	8	8	8	8	8	8	10	10	10	10	12	12
150	6	6	8	8	8	8	8	8	8	8	8	8	10	10	10	12	12	12	12
200	6	8	8	8	8	8	8	8	8	10	10	12	12	12	14	14	16	16	16
300	8	8	8	8	8	10	10	12	12	14	16	16							
400	8	8	8	8	10	12	14	16	16										
500	8	8	8	10	12	14	16	16											

Max. absorption of energy per ESL	
ESL 38	250 Nm
ESL 45	375 Nm
ESL 50	750 Nm
ESL 50-1.6	1000 Nm
ESL 50-2	1250 Nm

At the transfer stations of large belt conveyor systems for the pit and quarry industries, some belt damages may occur on the next downstream conveyor generated by the high impact force of falling sharp-edged mineral lumps. Furthermore, the continuously undamped material impacts of sharp and abrasive mineral lumps cause a high material wear on the very expensive belts, shortening considerably their lifetime.

Transfer or impact stations equipped with ROSTA anti-vibration mounts type ESL offer an effective absorption of the occurring kinetic energy of falling lumps with their progressive deflection characteristics. The belt surface is protected from scissures and high abrasion wear. **Please ask for our specific information manual "Impact Beds" and "Elastic Garland Suspensions".**



ROSTA Anti-vibration Mounts as customized system elements

Cost optimized anti-vibration mount type V 18 for large series application

Pre-investment study for a high volume need of anti-vibration mounts type V 18. The housing of the mount is planned as "endless" light metal extrusion profile, cut in required element lengths.



Cab assembly suspension on all-wheel crane truck

Tearproof low frequency suspension of the driver's cab on an off-road crane truck. These specific crane trucks are planned for the employment in pathless areas for the pipeline emplacement. The elastic suspensions of the driver's cab shall offer a high comfort at road transfer of the vehicle – and should offer a very high side stability while off-road acting without indefinable "floatage" of the cab. Cab suspension with four ESL 50 mounts and customized brackets.



Tearproof mounting of wind generators on anti-vibration mounts type V 45

Tearproof installation of wind generators on high steel girder masts and building roofs. On the one hand the anti-vibration mounts type V 45 avoid the transmission of vibrations and solid-borne noise from the wind generator on the building or structure, on the other hand the absolutely tearproof suspensions offer safe stability at strong wind emergence.



Applications!

A few examples:



Anti-vibration Mounts



ROSTA AG
CH-5502 Hunzenschwil
Phone +41 62 889 04 00
Fax +41 62 889 04 99
E-Mail info@rosta.ch
Internet www.rosta.com

Changes regarding contents reserved.
Any reprint, also in extracts, requires our explicit and confirmed approval.